



- Equipped with INGUN test probes
- Suitable for test fixtures with internal or external Pylon interface
- Consistently low contact resistances and replicable measured values
- High contact reliability and transmission quality
- Reliable transmission of radio-frequency signals within the scope of the specification

Application

Interface blocks (SB) are used to reliably transmit signals between test device and test system in internal and external Pylon interfaces. Radio-frequency blocks are suitable for the reliable transmission of frequencies within the scope of their specification.

Signal transmission

The signal is transmitted via two opposing interface blocks, which are designed for a working distance of 15.1 ± 0.5 mm between their mounting surfaces.

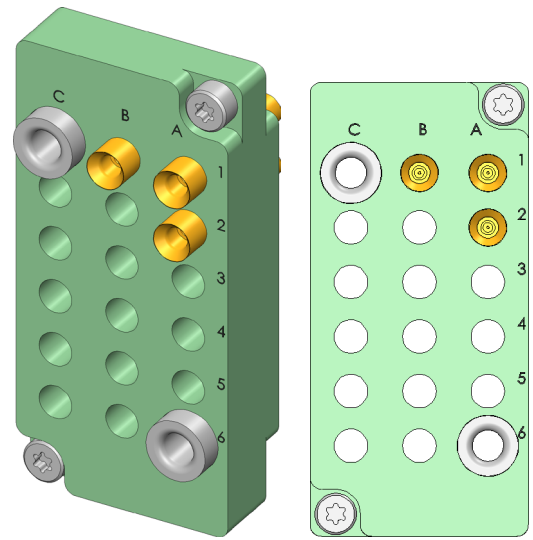

1:1

Delivery

The product is delivered partially assembled in the specified position, including assembly material.

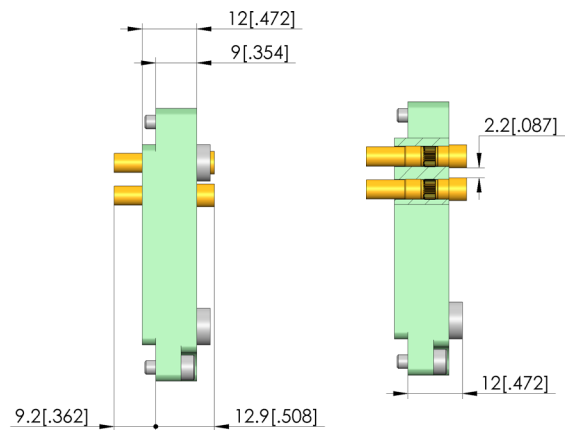
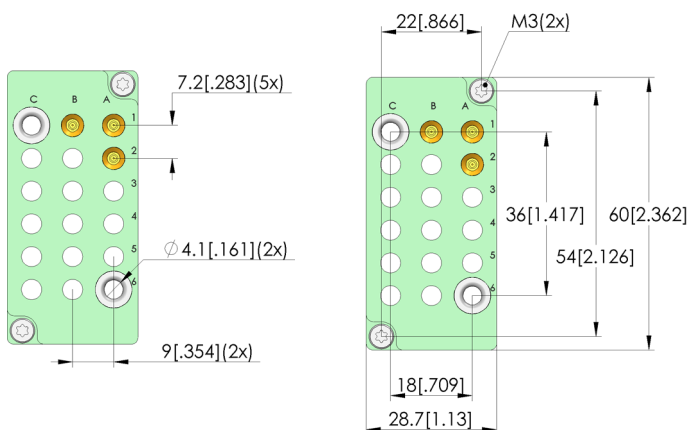

Interface block

SB-P-HF-016-4GHz-03-Z

Item 38183



GO TO PRODUCT

ingun[®]

Partner for Future Technology

General data

Product group:	Interface blocks (SB)
Series:	SB-HF
Type:	Radio-frequency block
Version:	Device under test (DUT) side
Accessory type:	Customising accessories
Component assembly:	SB-810-Z (MCX)
Weight:	0.036 kg [.079 lbs]
Min. temperature:	-30 °C [-22 °F]
Max. temperature:	80 °C [176 °F]
RoHS-compliant:	Yes

Electrical data

Impedance:	50 Ohm
------------	--------

Compatible with

Compatible mating part 1:	SB-T-HF-016-4GHz-03-Z
MA exchangeable kits (ATS MA):	ATS MAxx

Technical data

Working distance:	15,1 +/- 0,5 mm
Centring pin:	+/- 0,3 mm
Connection:	SE-EF316D-0015
Number of poles:	3 (fixed positions)
Frequency up to:	4 GHz

INGUN Prüfmittelbau GmbH

Max-Stromeyer-Straße 162
78467, Constance, Germany
Phone +49 7531 8105-0
Customer hotline +49 7531 8105-888
Fax +49 7531 8105-65
info@ingun.com

