



- Cable adapter for test plug 113658 (PS-HSAL2-M-012-G5-B-01)
- For soldering cables - stranded wires AWG 25 and higher - to the test system.
- Shielded housing
- Adjustable cable strain relief

NEW

INGUN SELECTION

Function and installation:

When soldering the contact element with an individual cable, 12-pole, AWG 25, or higher, solder in the slot of the pins to ensure the solder joint does not protrude beyond the outer diameter of the contact element. Press the contact elements in fully using the SW-ZW-GKS-075 insertion tool. Observe the specific pin configuration (1-12). Then screw the housing onto the test plug using 2x M1.6 screws and tighten the cable strain relief if required.

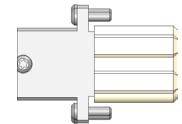
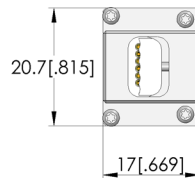
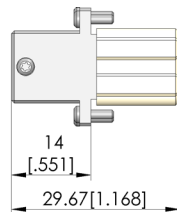
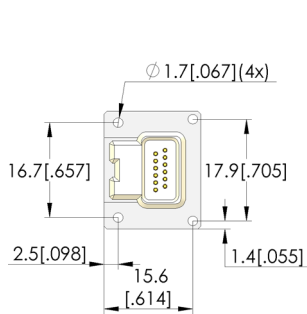
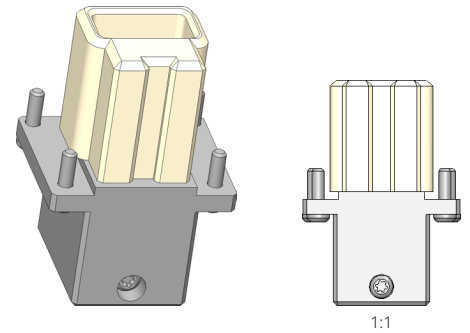

M1.6x6 T5 (5x)

General data

Product group:
Series:
Sub-series:
Min. temperature:
Max. temperature:
RoHS-compliant:

Plug (SE)
SE-HSAL
SE-HSAL connector
0 °C [32 °F]
50 °C [122 °F]
Yes

Connector data

Interface 1:
Interface gender 1:
Version 1:

HSAutolink2
F signal conductor female / socket
Straight

PS-HSAL2-M-012-G5-B-01

SE-HSAL2-12-M-G-000

Item 114617



GO TO PRODUCT

ingun®

Partner for Future Technology

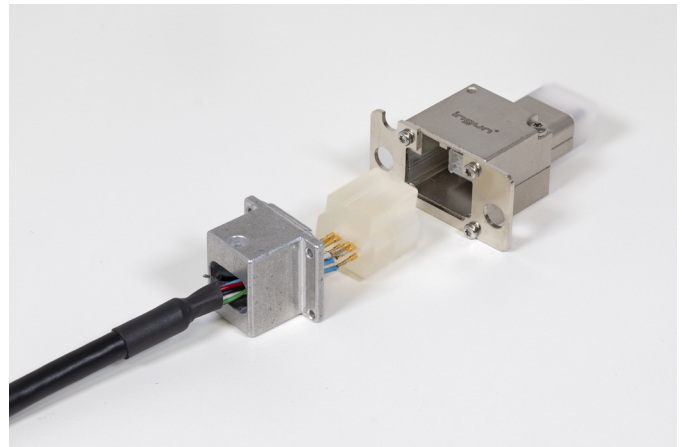
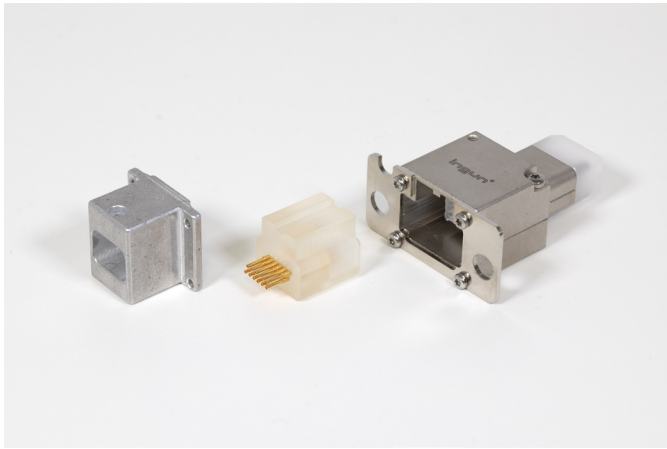
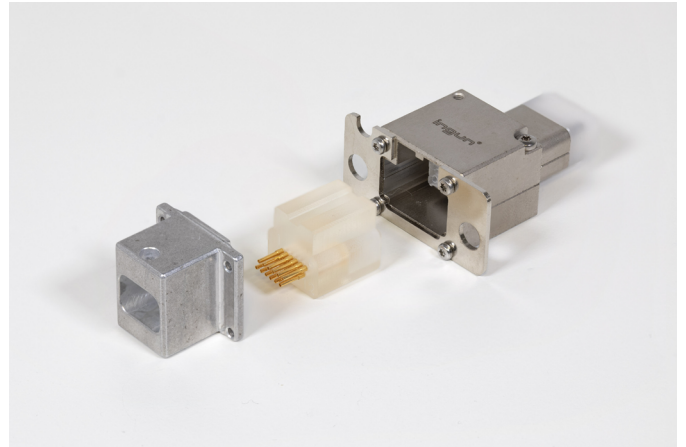
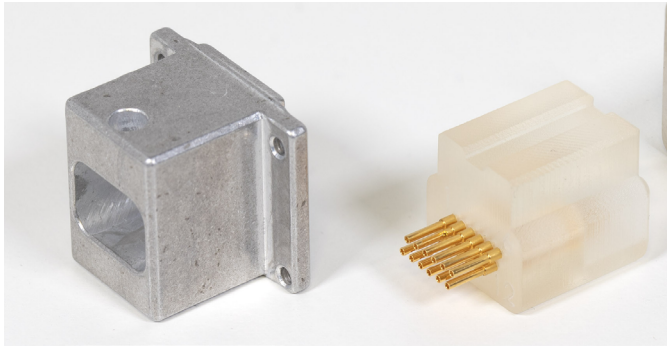

INGUN Prüfmittelbau GmbH

Max-Stromeyer-Straße 162
78467, Constance, Germany
Phone +49 7531 8105-0
Customer hotline +49 7531 8105-888
Fax +49 7531 8105-65
info@ingun.com



Prices and delivery times on request.
Technical changes reserved. 04/26_GB

Learn more about
Test probes

