



- Adaptador de cable para enchufe de prueba 113658 - PS-HSAL2-M-012-G5-B-01
- Para soldar cables propios al sistema de prueba, alambres trenzados AWG25 y superiores.
- Carcasa blindada
- Descarga de tracción del cable sujetable

#### Función y montaje:

When soldering the contact element with an individual cable, 12-pole, AWG 25, or higher, solder in the slot of the pins to ensure the solder joint does not protrude beyond the outer diameter of the contact element. Press the contact elements in fully using the SW-ZW-GKS-075 insertion tool. Observe the specific pin configuration (1-12). Then screw the housing onto the test plug using 2x M1.6 screws and tighten the cable strain relief if required.

### INGUN SELECTION

NEW

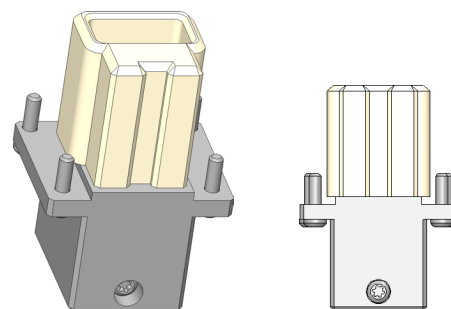

1:1

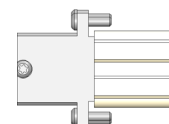
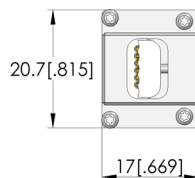
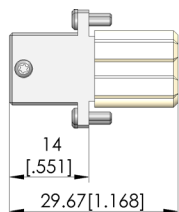
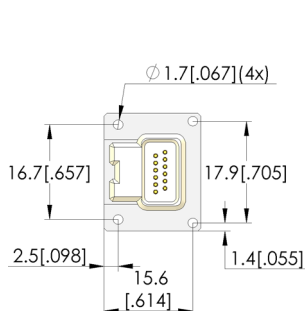

M1.6x6 T5 (5x)

#### Datos generales

Grupo de productos:  
Serie:  
Subserie:  
Temperatura mín.:  
Temperatura máx.:  
Conforme RoHS:

Enchufe (SE)  
SE-HSAL  
Enchufe SE-HSAL  
0 °C  
50 °C  
Sí

#### Datos de conector

Interfaz 1: HSAutolink2  
Sexo 1: F Conductor de señal hembra / conector hembra / hembrilla / Jack  
Modelo 1: recto

PS-HSAL2-M-012-G5-B-01

SE-HSAL2-12-M-G-000

Artículo 114617



DIRECTAMENTE AL PRODUCTO

ingun®

Partner for Future Technology

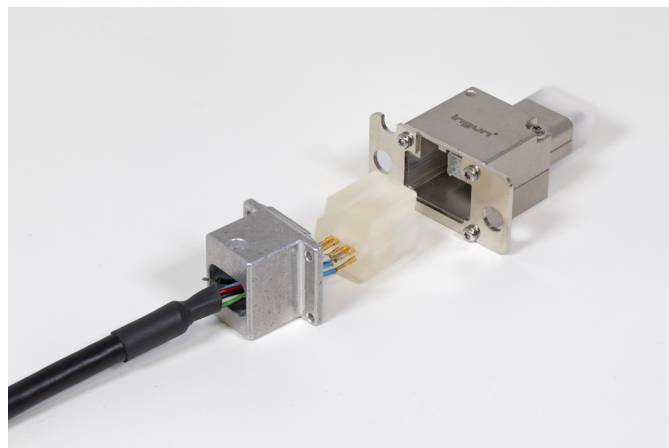
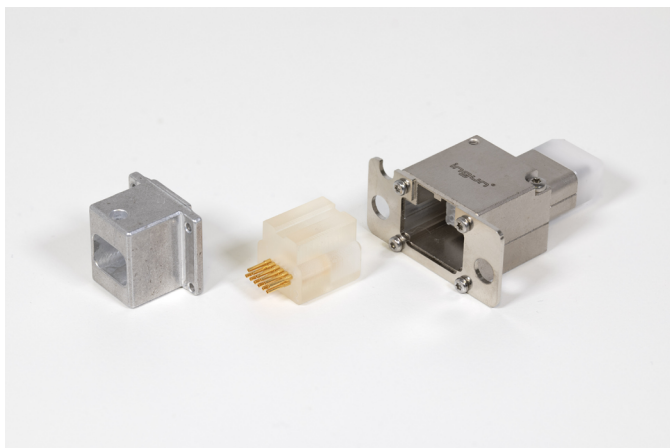
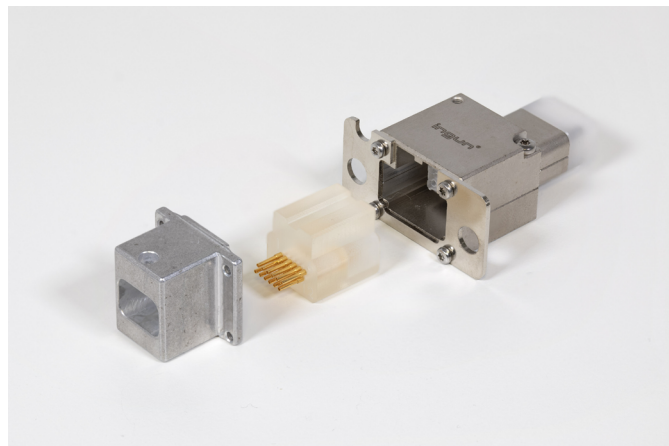
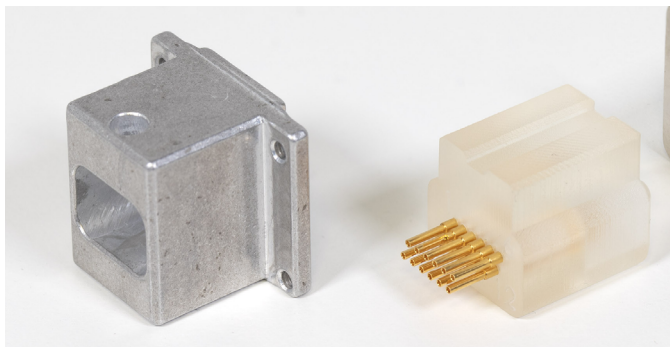

#### INGUN Prüfmittelbau GmbH

Max-Stromeyer-Straße 162  
78467, Constance, Germany  
Phone +49 7531 8105-0  
Customer hotline +49 7531 8105-888  
Fax +49 7531 8105-65  
info@ingun.com



Precios y plazos de entrega a consultar.  
Cambios técnicos reservados. 04/26\_ES

Más información sobre el tema  
Puntas de prueba

