



- Equipped with INGUN test probes
- Suitable for test fixtures with internal or external Pylon interface
- Consistently low contact resistances and replicable measured values
- High contact reliability and transmission quality
- Reliable transmission of radio-frequency signals within the scope of the specification

Application

Interface blocks (SB) are used to reliably transmit signals between test device and test system in internal and external Pylon interfaces. Radio-frequency blocks are suitable for the reliable transmission of frequencies within the scope of their specification.

Signal transmission

The signal is transmitted via two opposing interface blocks, which are designed for a working distance of 15.1 ± 0.5 mm between their mounting surfaces.

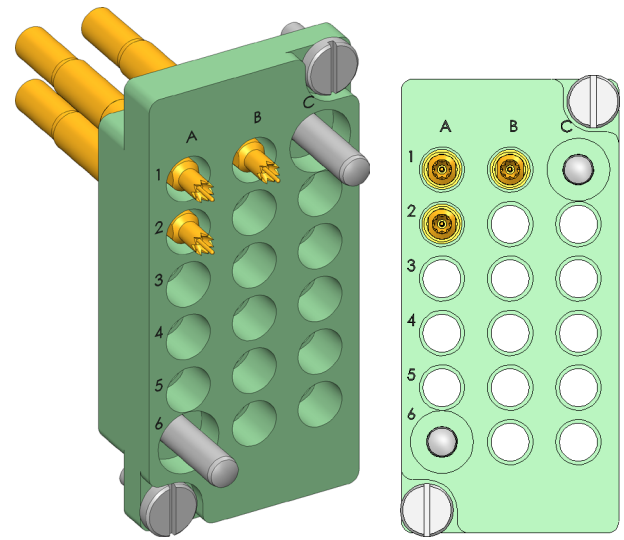

1:1

Delivery

The product is delivered partially assembled in the specified position, including assembly material.

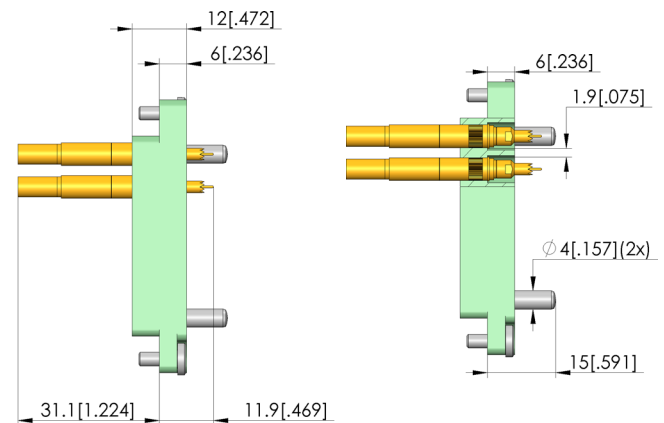
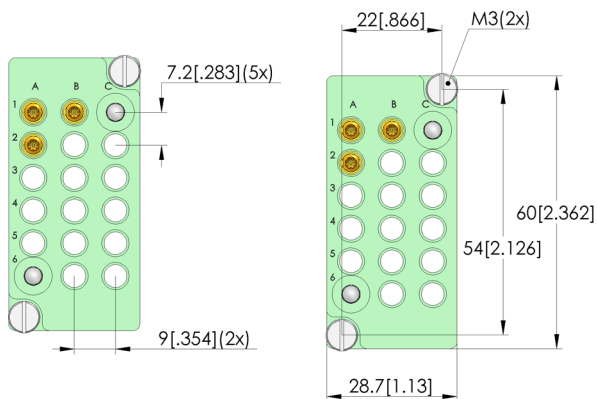

General data

Product group:	Interface blocks (SB)
Series:	SB-HF
Type:	Radio-frequency block
Version:	Test system side
Accessory type:	Customising accessories
Component assembly:	HFS-840-0093 & KS-810R
Weight:	0.026 kg [.057 lbs]
Min. temperature:	-30 °C [-22 °F]
Max. temperature:	80 °C [176 °F]
RoHS-compliant:	Yes

Compatible with

Compatible mating part 1:	SB-P-HF-016-4GHz-03-Z
Manual test fixtures (MA):	MA 21xx
Pylon receiver:	RC-PYLON-12-V2

Technical data

Working distance:	15,1 +/- 0,5 mm
Centring pin:	+/- 0,3 mm
Connection:	SE-EF316D-0015
GKS working stroke :	4 mm [.157 in]
Spring force:	15.9 N [57.1 ozf]
Frequency up to:	4 GHz

Electrical data

Impedance:	50 Ohm
------------	--------

INGUN Prüfmittelbau GmbH

Max-Stromeyer-Straße 162
78467, Constance, Germany
Phone +49 7531 8105-0
Customer hotline +49 7531 8105-888
Fax +49 7531 8105-65
info@ingun.com

